

# ***GSTD 2012/7 - Goods and services tax: when are supplies of interconnection services made by an Australian resident telecommunication supplier GST-free under item 2 in the table in subsection 38-190(1) of the A New Tax System (Goods and Services Tax) Act 1999?***

! This cover sheet is provided for information only. It does not form part of *GSTD 2012/7 - Goods and services tax: when are supplies of interconnection services made by an Australian resident telecommunication supplier GST-free under item 2 in the table in subsection 38-190(1) of the A New Tax System (Goods and Services Tax) Act 1999?*

! From 1 July 2015, the term 'Australia' is replaced in nearly all instances within the GST, Luxury Car Tax, and Wine Equalisation Tax legislation with the term 'indirect tax zone' by the *Treasury Legislation Amendment (Repeal Day) Act 2015*. The scope of the new term, however, remains the same as the now repealed definition of 'Australia' used in those Acts. This change was made for consistency of terminology across the tax legislation, with no change in policy or legal effect. For readability and other reasons, where the term 'Australia' is used in this document, it is referring to the 'indirect tax zone' as defined in subsection 195-1 of the GST Act.

! This document has changed over time. This is a consolidated version of the ruling which was published on *13 August 2025*



## Goods and Services Tax Determination

Goods and services tax: when are supplies of interconnection services made by an Australian resident telecommunication supplier GST-free under item 2 in the table in subsection 38-190(1) of the *A New Tax System (Goods and Services Tax) Act 1999*?

**!** This publication provides you with the following level of protection:

This publication is a public ruling for the purposes of the *Taxation Administration Act 1953*.

A public ruling is an expression of the Commissioner's opinion about the way in which a relevant provision applies, or would apply, to entities generally or to a class of entities in relation to a particular scheme or a class of schemes.

If you rely on this ruling, the Commissioner must apply the law to you in the way set out in the ruling (unless the Commissioner is satisfied that the ruling is incorrect and disadvantages you, in which case the law may be applied to you in a way that is more favourable for you – provided the Commissioner is not prevented from doing so by a time limit imposed by the law). You will be protected from having to pay any underpaid tax, penalty or interest in respect of the matters covered by this ruling if it turns out that it does not correctly state how the relevant provision applies to you.

(Note: this is a consolidated version of this document. Refer to the Legal Database ([ato.gov.au/law](http://ato.gov.au/law)) to check its currency and to view the details of all changes.)

| Table of Contents  | Paragraph |
|--|-----------|
| Background   | 1         |
| Services covered by this Determination   | 3         |
| <i>International Direct Dialling calls</i>   | 6         |
| <i>Video conferencing</i>  | 7         |
| <i>Toll-free calling</i>   | 8         |
| <i>Mobile satellite calls</i>  | 9         |
| <i>Reverse charge calls</i>  | 10        |
| <b>Ruling</b>  | <b>11</b> |
| Examples   | 19A       |
| <u>Example 1 – International Direct Dialling – overseas person calls Australia – use of Australian telecommunication supplier's network</u>                        | 20        |
| <u>Example 2 – IDD reverse charge call – overseas person is reverse charged for a call from Australia – use of Australian telecommunication supplier's network</u> | 23        |

**GSTD 2012/7**

|   |           |
|---|-----------|
| <u>Example 3 – Global roaming – employee of Australian subscriber is overseas – makes and receives calls – use of Australian telecommunication supplier's network</u>   | 26        |
| <u>Example 4 – Toll-free calling – made by customer of an overseas company while they are in Australia</u>  | 31        |
| <u>Example 5 – International call directed through Australia – overseas person makes a call, directed through Australia, to a person in another country – use of Australian telecommunication supplier's network</u>  | 37        |
| <u>Example 6 – Facilities managed call centre services – made by an Australian telecommunication supplier to a non-resident</u>   | 40        |
| <u>Example 7 – Satellite telephone – overseas person using an Australian satellite phone calls another overseas person from a ship outside Australia – use of the Australian telecommunication supplier's network</u> | 45        |
| <u>Example 8 – Satellite telephone – overseas person calls another overseas person who is on a ship outside Australia – call is routed through Australian telecommunication supplier</u>                              | 48        |
| <u>Example 9 – Video conference interconnection services – Australian telecommunication supplier supplies video conferencing to overseas telecommunication company</u>  | 51        |
| <u>Example 10 – Regional telecommunication Service – overseas telecommunication company subcontracts with an Australian telecommunication supplier to provide necessary Australian telecommunication supplies</u>     | 54        |
| <b>Date of effect</b>   | <b>57</b> |

**Background**

1. The question addressed in this Determination was considered amongst others in issue 3 of the Telecommunications Industry Liaison Group – Issues Register (issues register). Issue 3 deals with the GST treatment of specific telecommunication supplies.<sup>1</sup>

2. The issues register was a public ruling for the purposes of former section 105-60 of Schedule 1 to the *Taxation Administration Act 1953* before 1 July 2010. The Commissioner's views in this Determination are consistent with those expressed in the issues register.

2A. From 1 July 2015, the term 'Australia' was replaced in nearly all instances within the GST, luxury car tax and wine equalisation tax legislation with the term 'indirect tax zone'. The scope of the term, however, remains the same as the now repealed definition of 'Australia' used in those Acts. This change was made for consistency of terminology across the tax legislation, with no change in policy or legal effect. In this Determination, the 'indirect tax zone' is referred to as 'Australia'.

<sup>1</sup> Other issues dealt with in the issues register are addressed in Goods and Services Tax Determinations GSTD 2012/8, GSTD 2012/9 and GSTD 2012/10.

**Services covered by this Determination**

3. In this Determination, a telecommunication supplier means a carrier or a carriage service provider as defined in the *Telecommunications Act 1997* or an internet service provider as defined in section 19 of the *Online Safety Act 2021*.

4. An interconnection service is a service that links telecommunication suppliers' networks to enable the transfer of calls or internet traffic between each other's networks. This allows users of one supplier to communicate with users of another supplier, or to access services provided by another supplier.

5. The interconnection services covered by this Determination are those supplied by telecommunication suppliers in delivering the following common telecommunication services.

***International Direct Dialling calls***

6. International Direct Dialling (IDD) calls occur when a subscriber of a telecommunication supplier places a call to an international destination number without the aid of an operator. IDD calls can be made from fixed lines or from mobile phones, but do not include global roaming calls.

***Video conferencing***

7. Video conferencing allows people in two or more locations to communicate by live simultaneous two-way video and audio transmissions.

***Toll-free calling***

8. A toll-free calling service involves a subscriber setting up a toll-free number with a telecommunication supplier. This allows callers to call the subscriber at no charge by dialling the toll-free number. The telecommunication supplier instead charges the subscriber for this service, which may include a charge for setting up the toll-free arrangement, a monthly fee and any additional usage charges.

***Mobile satellite calls***

9. Mobile satellite calls are made through a mobile satellite service. It is a service provided by a satellite system which communicates with satellite phones on the ground. A call from a satellite phone goes to a satellite overhead, which routes it back down to land. From there the call passes into the telecommunication supplier's phone network for connection to a subscriber.

***Reverse charge calls***

10. A reverse charge service involves a caller phoning a telephone subscriber's mobile or fixed line by using a reverse charge access number. The reverse charge call is only connected if the receiving party accepts the call and charges.

**Ruling**

11. Supplies of interconnection services made by an Australian resident telecommunication supplier to a non-resident are GST-free under table item 2 of subsection 38-190(1) (item 2) of the *A New Tax System (Goods and Services Tax) Act 1999* (GST Act) if the non-resident is not in Australia<sup>3</sup> when the thing<sup>4</sup> supplied is done, and:

- the supply is neither a supply of work physically performed on goods situated in Australia when the work is done nor a supply directly connected with real property situated in Australia,<sup>5</sup> or
- the non-resident acquires the thing in carrying on the non-resident's enterprise, but is not registered or required to be registered.

11A. All further legislative references in this Ruling are to the GST Act, unless otherwise indicated.

12. The application of item 2 is limited,<sup>6</sup> however, by subsection 38-190(3), which prevents a supply of interconnection services covered by item 2 from being GST-free where the supply is provided to another entity in Australia.

13. Under subsection 38-190(3) a supply covered by item 2 is not GST-free if:

- it is a supply under an agreement entered into, whether directly or indirectly, with a non-resident (paragraph 38-190(3)(a)); and
- the supply is provided, or the agreement requires it to be provided, to another entity in Australia (paragraph 38-190(3)(b)); and
- for a supply other than an input taxed supply, none of the following applies:
  - the other entity would be an Australian-based business recipient of the supply, if the supply had been made to the other entity;
  - the other entity is an individual who is provided with the supply as an employee or officer of an entity that would be an Australian-based business recipient of the supply, if the supply had been made to it; or
  - the other entity is an individual who is provided with the supply as an employee or officer of the recipient and the recipient's acquisition of the thing is solely for a creditable purpose and is not a non-deductible expense.

13A. Subsection 9-26(2) provides that an entity is an Australian-based business recipient of a supply made to the entity if:

- the entity is registered; and

<sup>2</sup> [Omitted.]

<sup>3</sup> The meaning of 'not in Australia' for the purposes of subsection 38-190(1) is explained in Goods and Services Tax Ruling GSTR 2004/7 *Goods and services tax: in the application of items 2 and 3 and paragraph (b) of item 4 in the table in subsection 38-190(1) of the A New Tax System (Goods and Services Tax) Act 1999*:

- *when is a 'non-resident' or other 'recipient' of a supply 'not in Australia when the thing supplied is done'?*
- *when is 'an entity that is not an Australian resident' 'outside Australia when the thing supplied is done'?*

<sup>4</sup> Defined in section 195-1 as 'anything that can be supplied or imported'.

<sup>5</sup> The meaning of 'work physically performed on goods' and 'directly connected with goods or real property' is discussed in Goods and Services Tax Ruling GSTR 2003/7 *Goods and services tax: what do the expressions 'directly connected with goods or real property' and 'a supply of work physically performed on goods' mean for the purposes of subsection 38-190(1) of the A New Tax System (Goods and Services Tax) Act 1999?*

<sup>6</sup> Item 2 is also subject to subsection 38-190(2) and subsection 38-190(2A) but these limitations are not relevant to this ruling.

- an enterprise of the entity is carried on in Australia; and
  - the entity's acquisition of the thing supplied is not solely of a private or domestic nature.
- 13B. Subsections 69-5(3) and (3A) define an acquisition as a 'non-deductible expense' if:
- it is not deductible under Division 8 of the *Income Tax Assessment Act 1997* (ITAA 1997) because of provisions of the ITAA 1997 dealing with entertainment expenses and so on; or
  - to the extent it is not deductible under Division 8 of the ITAA 1997 because of provisions of the *Income Tax Assessment Act 1936* dealing with meal entertainment or an entertainment facility.
14. The supply of an interconnection service satisfies paragraph 38-190(3)(a) where the interconnection service is supplied under an agreement entered into by an Australian resident telecommunication supplier, directly or indirectly, with a non-resident entity.
15. For the purposes of paragraph 38-190(3)(b), the word *provided* is to be contrasted with the term *made* in item 2. Consistent with the views expressed in Goods and Services Tax Ruling GSTR 2025/1,<sup>7</sup> the Commissioner considers that 'provided' in the context of subsection 38-190(3) is used, in relation to a supply covered by item 2, to distinguish between the contractual flow of the supply made to a non-resident recipient (a non-resident telecommunication supplier) and the actual flow of the service or other things provided to another entity (a subscriber) in Australia.<sup>8</sup>
16. A supply of interconnection services is made to a non-resident telecommunication supplier but it is provided to a subscriber to enable them to make or receive a call. The supply is provided to the person who subscribed to the particular telecommunication service to which the interconnection services relate.
17. Further guidance in relation to the Commissioner's view of the distinction between a supply made and a supply provided is contained in GSTR 2025/1.
18. For the purposes of paragraph 38-190(3)(b), the entity to whom the supply of the interconnection service is provided must be in Australia when the thing supplied is done.<sup>9</sup>
19. When the supply of an interconnection service is made between two telecommunication carriers to enable a subscriber of one carrier to communicate with a subscriber of the other carrier, the supply is *made* to the carrier but *provided* to the subscriber who receives the actual flow of the supply. Where that subscriber is not an Australian-based business recipient and is in Australia, the effect of subsection 38-190(3) is to 'negate' the operation of item 2 so that the supply is not GST-free.

---

### **Examples**

- 19A. In all the examples:
- the supply of the interconnection services is neither a supply of work physically performed on goods situated in Australia when the work is done nor a supply directly connected with real property situated in Australia;

---

<sup>7</sup> Goods and Services Tax Ruling GSTR 2025/1 *Goods and services tax: supplies of things (other than goods or real property) made to non-residents but provided to another entity in Australia*. The meaning of 'a supply is provided to another entity' is explained at paragraphs 44 to 48.

<sup>8</sup> 'Determining whether the supply is provided to that other entity in Australia' is explained at paragraphs 44 to 48 of GSTR 2025/1.

<sup>9</sup> The meaning of the supply being provided to the entity in Australia when the thing supplied is done is explained in GSTR 2025/1 at paragraphs 44 to 48.

**GSTD 2012/7**

- the non-resident telecommunication supplier acquires the interconnection services in carrying on its enterprise; and
- the non-resident telecommunication supplier is not registered or required to be registered for GST in Australia.

**Example 1 – International Direct Dialling – overseas person calls Australia – use of Australian telecommunication supplier's network**

20. Tim is a New Zealand resident who uses his home telephone to call a friend in Australia. Tim has a contract with a New Zealand telecommunication supplier which is also a New Zealand resident company (NZ Telco) which charges him for making the call. NZ Telco routes the call to Australia, through an Australian telecommunication supplier's network (Aus Telco). Aus Telco makes a supply of interconnection services to NZ Telco and charges a fee.

21. The supply of interconnection services, which involves the connection of Tim's call to his friend in Australia, made by Aus Telco to NZ Telco (a non-resident which is not in Australia) is GST-free under item 2.

22. As the actual flow of the supply is to Tim, the supply is provided to Tim who is not in Australia. Therefore, subsection 38-190(3) does not negate the GST-free status of the supply covered by item 2.

Diagram 1: Supply of interconnection services

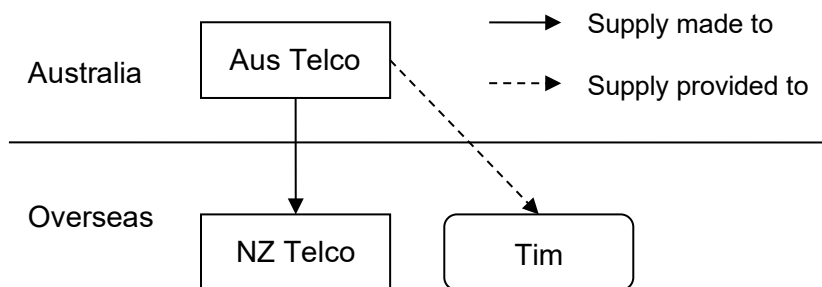
**Example 2 – IDD reverse charge call – overseas person is reverse charged for a call from Australia – use of Australian telecommunication supplier's network**

23. Jacqui is an Australian resident who uses her home telephone to reverse charge a call to a friend, Peter, in New Zealand. Peter is charged by NZ Telco for accepting the call. Aus Telco makes a supply of interconnection services to NZ Telco and charges a fee.

24. The supply of interconnection services, which involves the connection of the call between Jacqui and Peter, made by Aus Telco to NZ Telco (a non-resident which is not in Australia) is GST-free under item 2.

25. The actual flow of the supply of interconnection services made by Aus Telco under an agreement entered into with NZ Telco is provided to Peter, a subscriber who agrees to accept the call and charge made through the reverse charge service. Peter is not in Australia when the supply is made. Therefore, subsection 38-190(3) does not negate the GST-free status of the supply covered by item 2.

<sup>10</sup> [Omitted.]

Diagram 2: Supply of interconnection services

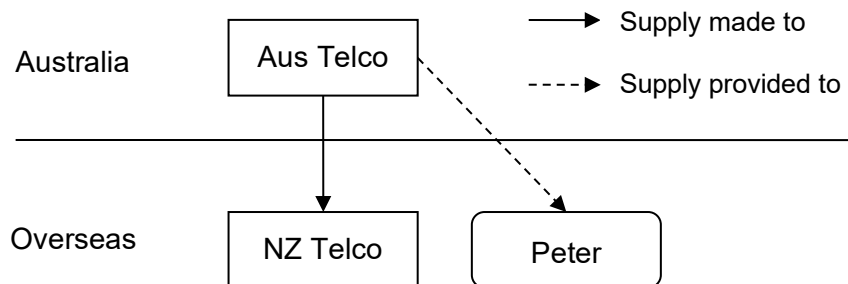

**Example 3 – Global roaming – employee of Australian subscriber is overseas – makes and receives calls – use of Australian telecommunication supplier’s network**

26. An Australian resident company, Aus Co, has a mobile phone agreement with Aus Telco. Greg, an employee of Aus Co, travels to China for business. Greg has a work mobile provided by Aus Co that is supplied under a mobile phone agreement with Aus Telco.

27. While in China, Greg accesses the mobile service through a Chinese Telecommunication supplier (China Telco) and uses his work mobile to make a call to and receive a call from a business contact in Australia.

28. The call is routed through China Telco. China Telco has an interconnection agreement with Aus Telco. Aus Telco makes a supply of interconnection services, which involves the connection of the call between Greg and his business contact in Australia, to China Telco and charges a fee.

29. The supply of the interconnection services made by Aus Telco to China Telco (a non-resident which is not in Australia) is GST-free under item 2.

30. The supply of interconnection services made by Aus Telco to China Telco is a supply under an agreement entered into with China Telco; the supply is provided to Greg. Greg is not in Australia when the supply is made. Therefore, subsection 38-190(3) does not negate the GST-free status of the supply.

Diagram 3: Supply of interconnection services

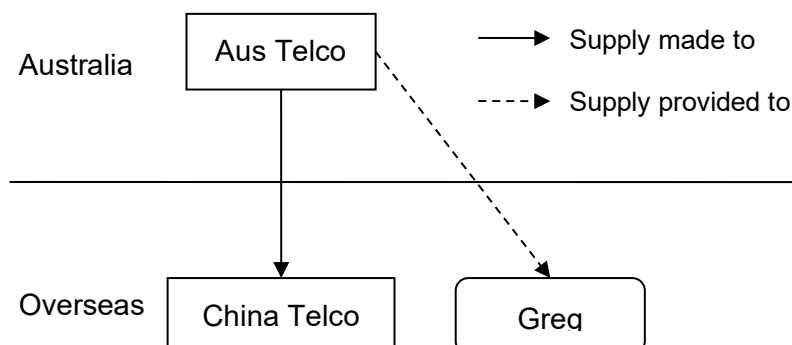

**Example 4 – Toll-free calling – made by customer of an overseas company while they are in Australia**

31. A New Zealand travel agency (NZ Travel Co) has an agreement with NZ Telco for a toll-free calling service. The arrangement allows the customers of NZ Travel Co on holiday in Australia to call the toll-free number and connect to the NZ Travel Co.

# GSTD 2012/7

32. Judy books a tour to Australia through NZ Travel Co. While in Australia, Judy contacts NZ Travel Co using the toll-free number to discuss a problem with the tour.
33. NZ Travel Co is charged by NZ Telco for the toll-free calling service, including a fee for setting up the toll-free arrangement, a monthly fee and any additional usage charges.
34. NZ Telco and Aus Telco have an interconnection services agreement. Aus Telco makes a supply of interconnection services to NZ Telco and charges a fee.
35. The supply of the interconnection service, which involves the connection of Judy's call to NZ Telco's toll-free number subscriber, NZ Travel Co, made by Aus Telco to NZ Telco (a non-resident which is not in Australia) is GST-free under item 2.
36. The supply of the interconnection services made by Aus Telco under an agreement with NZ Telco is provided to NZ Telco's toll-free number subscriber, NZ Travel Co. NZ Travel Co is not in Australia when the supply is made. Therefore, subsection 38-190(3) does not negate the GST-free status of the interconnection services supply.

Diagram 4: Supply of interconnection services

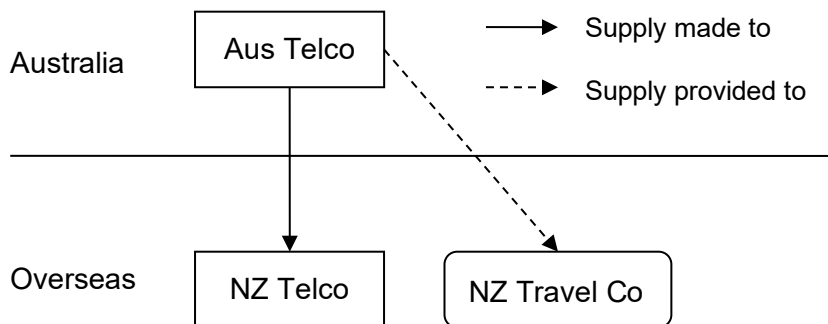

**Example 5 – International call directed through Australia – overseas person makes a call, directed through Australia, to a person in another country – use of Australian telecommunication supplier's network**

37. Leone, a resident of Belgium, is a subscriber to Belgium Telco (a Belgian resident telecommunication supplier). She subscribes to the IDD facility offered by Belgium Telco. Leone makes a call to Tony in Papua New Guinea. The call is routed via Aus Telco. Aus Telco has an interconnection services agreement with Belgium Telco. Aus Telco makes a supply of interconnection services to Belgium Telco and charges a fee.
38. The supply of the interconnection service, which involves the connection of Leone's call to Tony, made by Aus Telco to Belgium Telco (a non-resident which is not in Australia) is GST-free under item 2.
39. The actual flow of the supply of the interconnection services made by Aus Telco under an agreement entered into with Belgium Telco is to their subscriber Leone. Leone is not in Australia when the supply is made. Therefore, subsection 38-190(3) does not negate the GST-free status of the supply covered by item 2.

Diagram 5: Supply of interconnection services

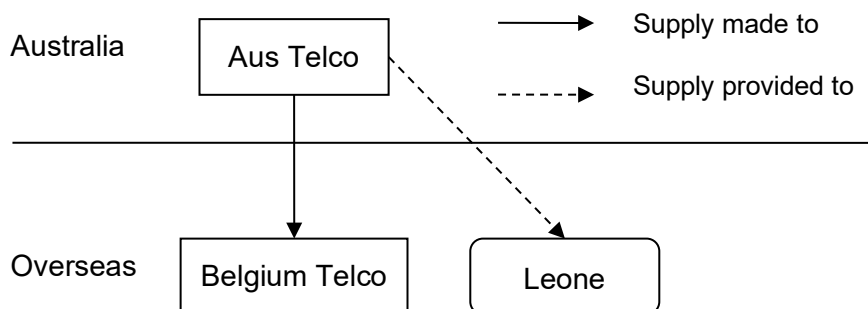

**Example 6 – Facilities managed call centre services – made by an Australian telecommunication supplier to a non-resident**

40. Aus Telco has an agreement with Konnichiha Airlines to provide call centre services whereby Aus Telco receives calls from Konnichiha Airlines' customers and provides call distribution and reservation services.

41. Prospective passengers in Japan call Konnichiha Airlines to book flights. Their calls are directly routed to Konnichiha Airlines' call centre in Australia where a customer service representative makes the reservation. Aus Telco charges Konnichiha Airlines for this service.

42. The supply of call centre services made by Aus Telco to Konnichiha Airlines (a non-resident company that is not in Australia) is GST-free under item 2.

43. The supply of call centre services involves receiving telephone calls, providing information and making reservations for Konnichiha Airlines and as such, the supply is made and provided to Konnichiha Airlines. While prospective customers receive information and make reservations, they are not provided with the service of a facilities managed call centre. This is provided to Konnichiha Airlines.<sup>11</sup>

44. Because the supply is made and provided to Konnichiha Airlines which is not in Australia when the supply is made, subsection 38-190(3) does not negate the GST-free status of the supply covered by item 2.

Diagram 6: Supply of interconnection services

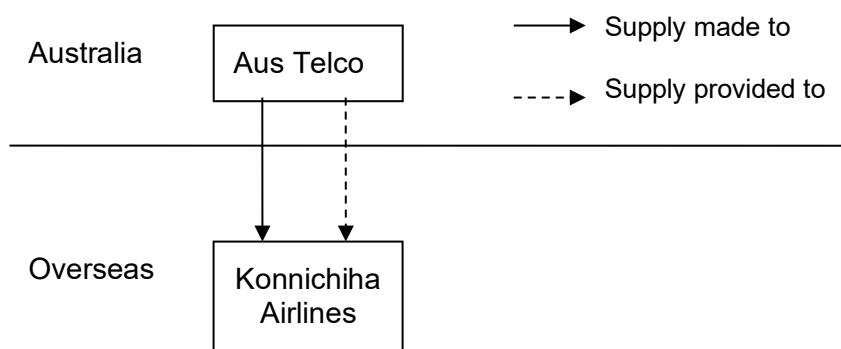

<sup>11</sup> The GST treatment in relation to Example 6 of this Ruling is not necessarily indicative of the treatment of a range of other supplies that may be delivered through call centre arrangements. It is necessary to identify what is being supplied through a call centre to determine the GST treatment of a supply. This is illustrated in Example 7 in GSTR 2025/1.

# GSTD 2012/7

**Example 7 – Satellite telephone – overseas person using an Australian satellite phone calls another overseas person from a ship outside Australia – use of the Australian telecommunication supplier's network**

45. Aus Telco supplies Carmel, a Fijian resident, with a satellite phone for use on her private yacht. Carmel uses the satellite phone to call a friend in New Zealand while on a trans-Tasman crossing. The call is routed via the Aus Telco's network in Australia. The call is made by Carmel from a ship outside Australia. The billing address for the satellite phone service is Carmel's address in Fiji.

46. The supply of the telecommunication service made by Aus Telco to Carmel (a non-resident who is not in Australia) is GST-free under item 2.

47. The supply of telecommunication services made by Aus Telco under an agreement entered into with Carmel is made and provided to her outside Australia. Therefore, subsection 38-190(3) does not apply to negate the GST-free status of the supply.

Diagram 7: Supply of interconnection services

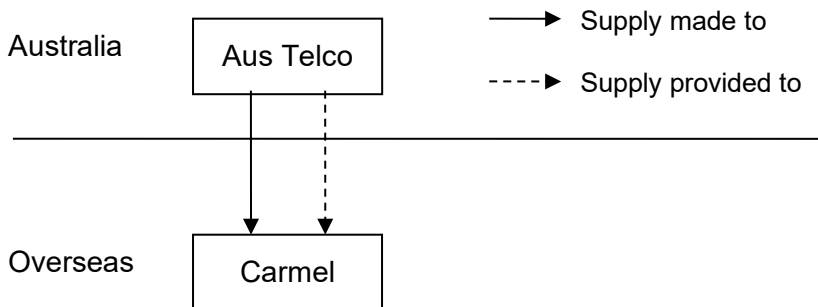

**Example 8 – Satellite telephone – overseas person calls another overseas person who is on a ship outside Australia – call is routed through Australian telecommunication supplier**

48. Brad is a resident of Guam and a subscriber of Guam Telco. Guam Telco is a non-resident that is not in Australia. Brad calls his friend who is on a cruise around the Pacific Islands. The call is routed through Aus Telco's network and via satellite to the ship. Aus Telco has an interconnection services agreement with Guam Telco. Aus Telco makes a supply of interconnection services to Guam Telco and charges a fee.

49. The supply of the interconnection services which involves the connection of Brad's call to his friend, made by Aus Telco to Guam Telco is GST-free under item 2.

50. The actual flow of the supply of the interconnection services made by Aus Telco under an agreement entered into with Guam Telco is provided to Brad. Brad is not in Australia when the supply is made. Therefore, subsection 38-190(3) does not negate the GST-free status of the supply covered by item 2.

Diagram 8: Supply of interconnection services

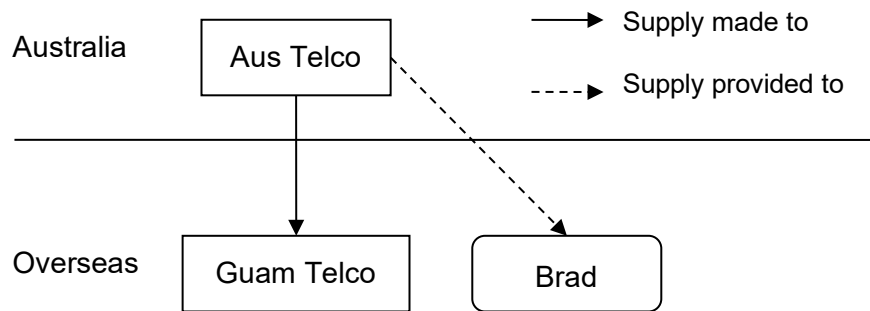

**Example 9 – Video conference interconnection services – Australian telecommunication supplier supplies video conferencing to overseas telecommunication company**

51. A New Zealand company (NZ Co) contracts with NZ Telco (a non-resident which is not in Australia) for video conferencing services between its sales staff in New Zealand and a potential customer in Australia (Aus Target Co). NZ Co is the registered contact and chair person for the video conference. It is the subscriber to the video conferencing service including the related video conferencing facilities. In order to provide the video conference service, NZ Telco obtains access to a bridge (a facility using interconnection software that is part of the overall telecommunication service) supplied by Aus Telco in Australia. NZ Co and Aus Target Co dial the bridge to start the video conference. In addition, both NZ Telco and Aus Telco provide video conference facilities (a room) for a separate fee. The room is integral to the supply of the video conferencing service.<sup>12</sup>

52. The supply of video conferencing services and facilities is a GST-free supply under item 2.

53. The supply of video conferencing services and facilities made by Aus Telco under an agreement entered into with NZ Telco is provided to NZ Telco's customer, NZ Co. NZ Co is the entity that has the contract with NZ Telco for the supply of the video conferencing services and facilities. NZ Co is not in Australia when the supply is made. Therefore, subsection 38-190(3) does not negate the GST-free status of the supply covered by item 2.

Diagram 9: Supply of interconnection services

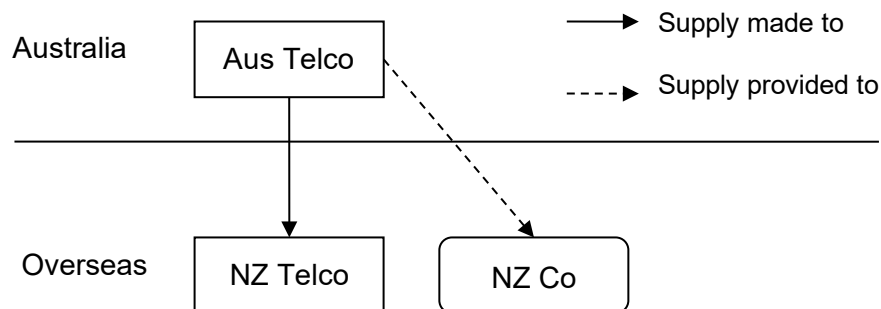

<sup>12</sup> The term 'integral' is explained in paragraph 55 to 63 of GSTR 2001/8 *Goods and services: apportioning the consideration for a supply that includes taxable and non-taxable parts*. The GST treatment of a composite supply that contains a dominant part and includes something that is integral is discussed in paragraph 17 to 18A of that ruling.

# GSTD 2012/7

**Example 10 – Regional telecommunication Service – overseas telecommunication company subcontracts with an Australian telecommunication supplier to provide necessary Australian telecommunication supplies**

54. A New Zealand company (NZ Co) enters into an arrangement with NZ Telco (a non-resident which is not in Australia) for the provision of trans-Tasman telecommunication supplies – it is the subscriber in relation to that telecommunication supply. The supply is a regional telecommunication service which allows NZ Co and Aus Co (the Australian resident member of the NZ Co group) to make or receive voice, data or other telecommunication services. NZ Telco contracts with Aus Telco to provide the necessary Australian telecommunication supplies, which are interconnection services.

55. The supply of the interconnection services, which allows the connection between NZ Co and Aus Co, made by Aus Telco to NZ Telco is GST-free under item 2.

56. The supply of interconnection services made by Aus Telco under an agreement entered into with NZ Telco is provided to NZ Co, NZ Telco's subscriber. NZ Co is not in Australia when the supply is made. Therefore, subsection 38-190(3) does not negate the GST-free status of the supply covered by item 2.

Diagram 10: Supply of interconnection services

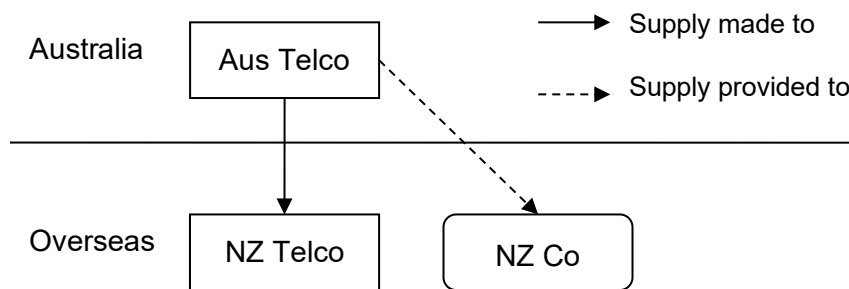

**Date of effect**

57. This Determination applies both before and after its date of issue. However, this Determination will not apply to taxpayers to the extent that it conflicts with the terms of a settlement of a dispute agreed to before the date of issue of this Determination (see paragraphs 75 and 76 of Taxation Ruling TR 2006/10).

---

## References

---

*Previous draft:*

GSTD 2012/D1

*Related rulings and determinations:*TR 2006/10; GSTR 2001/8; GSTR 2003/7;  
GSTR 2004/7; GSTR 2025/1; GSTD 2012/8;  
GSTD 2012/9; GSTD 2012/10*Legislative references:*

- ANTS(GST)A 1999 9-26(2)
- ANTS(GST)A 1999 38-190(1)
- ANTS(GST)A 1999 38-190(2)
- ANTS(GST)A 1999 38-190(2A)
- ANTS(GST)A 1999 38-190(3)

- ANTS(GST)A 1999 38-190(3)(a)
- ANTS(GST)A 1999 38-190(3)(b)
- ANTS(GST)A 1999 69-5(3)
- ANTS(GST)A 1999 69-5(3A)
- ANTS(GST)A 1999 195-1
- ITAA 1997 Div 8
- TAA 1936
- TAA 1953 former Sch 1 105-60
- Online Safety Act 2021 19
- Telecommunications Act 1997

*Other references:*

- Telecommunications Industry Liaison Group – Issues Register

---

**ATO references**

NO: 1-3XH7YY6

ISSN: 2205-6254

ATOlaw topic: Goods and services tax ~~ International ~~ Telecommunications

---

© AUSTRALIAN TAXATION OFFICE FOR THE COMMONWEALTH OF AUSTRALIA

You are free to copy, adapt, modify, transmit and distribute this material as you wish (but not in any way that suggests the ATO or the Commonwealth endorses you or any of your services or products).